

**JPD-FR409**

**CE**0482

**JUMPER**

**Infrared Thermometer  
Instruction Manual**

**Shenzhen Jumper Medical Equipment Co., Ltd**

Manual Version: 1.1

Date of Issue: 2018/09/13



## **Product Information**

Product Name: Infrared Thermometer

Model: JPD-FR409

Manufacturer: Shenzhen Jumper Medical Equipment Co., Ltd

Address: D Building, No. 71, Xintian Road, Fuyong Street, Baoan, Shenzhen, Guangdong, China.

## **Copyright**

Copyright © Jumper Medical.

All rights reserved.

## **Statement**

Shenzhen Jumper Medical Equipment Co., Ltd. owns and reserves all of the rights comprised in the copyright of this document. No part of this document may be changed, excerpted, copied, reproduced, or imitated in any form or by any means without the prior consent of Shenzhen Jumper Medical Equipment Co., Ltd.

All statements, information, and recommendations in this document are provided "AS IS" without warranties, guarantees or representations of any kind, either express or implied. The information in this document is subject to change without notice. Shenzhen Jumper Medical Equipment Co., Ltd. reserves the right of final interpretation of this document.

## **Introduction**

Thank you for purchasing this Infrared Thermometer. Please read the User Manual carefully to make sure safe and proper use of this thermometer.

Please read and fully understand the Safety Precautions before use.

**Keep the Instruction Manual with this thermometer for future reference.**

## Contents

Unpacking Check.....	1
Package Contents.....	1
Safety Precautions.....	2
Warning .....	4
Symbols .....	5
Body Temperature Basics.....	6
Product Description .....	7
Features.....	8
Product structure.....	9
Display description .....	9
Sounds and backlight instructions.....	10
Display and Operating Instructions .....	11
Measuring Ear Temperature .....	17
Measuring Forehead Temperature .....	19
Measuring Object Temperature .....	20
Replacing Batteries .....	22
Cleaning and Disinfection.....	23
Maintenance.....	24
Troubleshooting .....	25
Specifications.....	26
Security Class .....	27
Storage and Transportation .....	27
EMC Information-Guidance and Manufacture's Declaration .....	28
Warranty and After-Sale Service .....	34

## Unpacking Check

Please open the package carefully before use, check whether all accessories are available or not and whether any component is damaged during transportation, and perform installation and operation following this user manual. In case of any damage or operation problem, please contact the dealer or contact Jumper directly. You will need the following information when making your claim: <sup>SEP</sup> device model, serial number, purchase date, and your contact information and address.

## Package Contents

No.	Name	Quantity
1	Infrared Thermometer	1
2	Pouch	1
3	Battery (AAA)	2
4	Instruction Manual	1

## Safety Precautions

Read the following precautions carefully before using the thermometer.



### Attention

- ◆ Take care of the temperature probe lens, which is fragile.
- ◆ Dispose used batteries with care. To protect the environment, you are recommended to send the used batteries to a designated collection point.
- ◆ Remove the batteries if the thermometer will not be used for more than two months.
- ◆ Do not immerse the thermometer in water or expose it to direct sunlight.
- ◆ Do not subject the thermometer to vibration or impact.
- ◆ The normal body temperature varies from person to person. Tracking a person's body temperature will help determine whether they have fever.
- ◆ Do not take body temperature readings within 20 minutes after you do physical exercises or get excited.
- ◆ Clean the thermometer probe after each use.
- ◆ Do not use the thermometer on newborns or for continuous temperature monitoring purposes.
- ◆ Do not use the thermometer for purposes that are not specified in this User's Manual. Follow the instructions in the "Measurement

<p>Process" chapter and carefully operate the thermometer when measuring children's temperature.</p>
<p>◆ Do not immerse the thermometer in water or other liquid, as it is not waterproof. Clean and disinfect the thermometer as described in the "Cleaning and Disinfection" chapter.</p>
<p>◆ Do not touch the tip of the temperature probe, on which a precise temperature sensor resides.</p>
<p>◆ Keep the temperature probe clean to make sure accurate readings.</p>
<p>◆ Before measuring the temperature from the ear canal, clean the earwax, if any.</p>
<p>◆ The ambient temperature must not be extremely high or low. To make sure accurate readings, keep the thermometer under room temperature for more than 30 minutes before use.</p>
<p>◆ Do not use the thermometer under an ambient temperature higher than 40°C (104°F) or lower than 10°C (50°F), which is beyond the operating temperature range of the thermometer.</p>
<p>◆ <b>Risk of pollution!</b> The user is recommended to send the overdue thermometer to local garbage disposal site or send it back to us.</p>
<p>◆ 2 AAA batteries of 1.5V are the only replaceable accessories of the thermometer. Please do not use the batteries of other voltages or specifications.</p>

## Warning













- Do not force the temperature probe of the thermometer into an ear canal. Otherwise, the ear canal may get injured.
- Keep the thermometer out of the reach of children.
- The result may be inaccurate if you use the overdue thermometer.
- The thermometer is not intended to diagnose or treat any health problem or disease. The measurement results are for reference only.
- It is dangerous to make a self-diagnosis or self-treatment based on the obtained measurement results. For such purposes, please consult a doctor.
- ⊘ Do not charge an alkaline dry-cell battery or throw it in fire. Otherwise, the battery may explode.
- ⊘ Do not disassemble the thermometer or attempt to repair it. Otherwise, the thermometer may be damaged permanently.
- ⊘ Do not take temperature measurements on body parts other than forehead and ears. Otherwise, the temperature readings may be inaccurate.
- ⊘ During measurement, do not use a mobile phone or any other device that may cause electromagnetic interference.



-  Do not use the thermometer in an environment where flammable anesthetic mixture with air or with oxygen or nitrous oxide is available.

## Symbols

Symbol	Description
	Type BF applied part.
	Attention must be paid.
	The action is prohibited.
	Information about the manufacturer.
	Date of manufacture.
	Consult the instructions for use.
	This product complies with the MDD93/42/EEC requirements.
	Waste electrical materials should be sent to a dedicated collection point for recycling.
 Warning	A personal injury or damage to the thermometer may occur if the thermometer is not used correctly.
 Attention	Inaccurate reading or damage to the thermometer may occur if the thermometer is not used correctly.

## Body Temperature Basics

Generally, you can take a body temperature on the forehead, in the ear canal, under the armpit, in the mouth, or in the anus. The temperature measured at different parts of the body may differ slightly.

Body Part	Normal Temperature Range
Forehead	36.1°C–37.5°C / 97.0°F–99.5°F
Ear canal	35.8°C–38.0°C / 96.4°F–100.4°F
Mouth	35.5°C–37.5°C / 95.9°F–99.5°F
Armpit	34.7°C–37.3°C / 94.5°F–99.1°F
Anus	36.6°C–38.0°C / 97.9°F–100.4°F

The normal body temperature range slightly varies with age and gender. Generally, newborns or children have higher body temperature than adults, and adults have higher body temperature than the elderly. Women's body temperature are appropriately 0.3°C higher than men's.

### Variation in body temperature

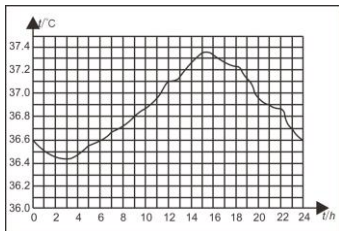

Normal body temperature varies by the time of day and is also affected by external factors. The body temperature of an individual is the lowest between 2:00 a.m. and 4:00 a.m. and the highest between 14:00 p.m. and 20:00 p.m. An individual's body temperature typically changes by less than 1°C each day.

## Product Description

### 1) Overview

Infrared Thermometer JPD-FR409 measures the body temperature based on the infrared energy emitted from the eardrum or the forehead. Users can quickly get measurement results after positioning properly the temperature probe in the ear canal or forehead.

### 2) Structure

The thermometer consists of a shell, an LCD, a measure button, a beeper, an infrared temperature sensor, and a Microprocessor.

### 3) Operating principle

The infrared temperature sensor collects infrared energy emitted by the eardrum or the skin surface. After being focused by a lens, the energy is converted into a temperature reading by the thermopiles and measurement circuits.

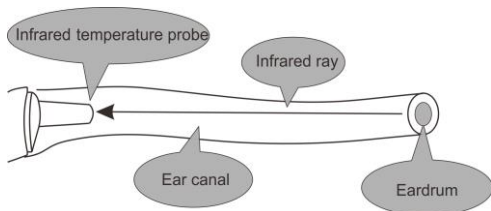

### 4) Intended use

The JPD-FR409 Dual Mode Digital Infrared Thermometer is intended for the measurement of human body temperatures. The forehead mode is indicated for use by people of all ages and the eardrum mode is indicated for use by people above three months old.

## 5) Contraindications

Do not use the thermometer if the ear is infected with otitis or suppuration.

## Features

- 01 Good safety
  - Passive infrared receiving technology.
- 02 Easy operation
  - Ergonomic design
  - One button measurement
- 03 Quick measurement
  - 1-second measurement
- 04 High accuracy
  - Advanced infrared temperature sensor, with high sensitivity
  - High accuracy with automatic temperature calibration
- 05 Diverse functions
  - 20 reading recalled
  - Fever alert
  - Switching between °C and °F
  - Automatic power-off, power saving
- 06 Extensive application scope
  - Forehead temperature measurement applicable to all age groups
  - Ear temperature measurement applicable to children older than three months, adults, and the elderly
- 07 Child mode
  - This mode is recommended for people under 12 years of age.

## Product structure

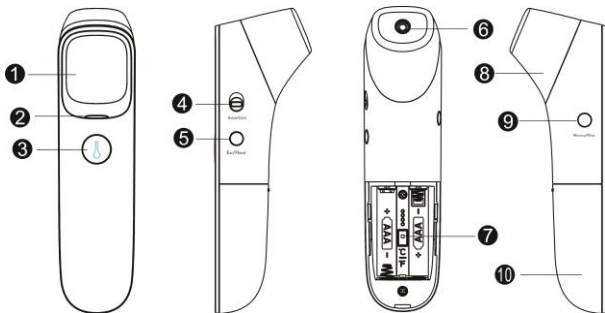

- (1) LCD display screen
- (2) Indicator
- (3) Power button / Measure button
- (4) Adult mode / Child mode
- (5) Mode button (Forehead / Ear / Object)
- (6) Probe (take off the cover when measuring the ear temperature)
- (7) Unit switch button (°C/°F)
- (8) Probe cover (put the cover on when measuring the forehead temperature)
- (9) Memory button / Sound switch
- (10) Battery cover

## Display description

1. Object temperature mode
2. Forehead temperature mode
3. Child mode
4. Ear temperature mode
5. Mute / un-mute
6. Fahrenheit / Celsius degrees
7. Low battery
8. Memory recall
9. Temperature value

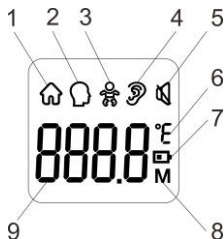



## Sounds and indicator color instructions



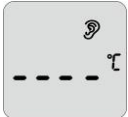

Range	Sounds	Indicator color
Forehead temperature (Adult / Child)		
35.0°C-37.5°C/95.0°F-99.5°F	A long beep	Green
37.6°C-42.2°C/99.6°F-108.0°F	3 short double beeps	Red
Ear temperature (Adult / Child)		
35.0°C-37.5°C/95.0°F-99.5°F	A long beep	Green
37.6°C-42.0°C/99.6°F-107.6°F	3 short double beeps	Red
Object temperature		
0°C-100°C/32.0°F-212°F	A long beep	Green

**Note:** When the forehead and the ear temperature is between 35.0°C/95.0°F and 37.5°C/99.5°F, there will be a long beep and a green indicator. This indicates that your body temperature is normal.

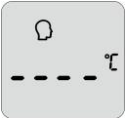

When the forehead temperature is between 37.6°C/99.6°F and 42.2°C/108.0°F, and the ear temperature is between 37.6°C/99.6°F and 42.0°C/107.6°F, there will be 3 short double beeps and a red indicator. This indicates that your body temperature is a little high. You may have a fever. Please consult your doctor if you are not sure.





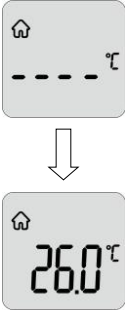

## Display and Operating Instructions



Screen Display	Operating Instructions Displayed State	Sound and Indicator color
Measuring Ear temperature (Adult / Child)		
 <p style="text-align: center;">↓</p>  <p>Ear temperature for adult</p>  <p>Ear temperature for child</p>	<p>Take off the probe cover, press and release the <b>Power button</b> for 1 second to power on the thermometer. Press the <b>Mode button</b>, the thermometer enters the <b>Ear mode</b>. The symbol “Ear” is displayed on the screen.</p> <p>Switch to the adult or child measurement mode by dialing the side adult/child switcher according to your measurement needs.</p> <p>Insert the temperature probe into a proper position in the ear canal. Press the <b>Measure button</b> to start a measurement.</p>	<p>See the table in the “Sounds and indicator color instructions” section.</p>
Measuring Forehead temperature (Adult / Child)		

Screen Display	Operating Instructions Displayed State	Sound and Indicator color
   Forehead temperature for adult  Forehead temperature for child	<p>Put the cover on the probe, press and release the <b>Power button</b> for 1 second to power on the thermometer. Press the <b>Mode button</b>, the thermometer enters the <b>Forehead mode</b>. The “Head” symbol is displayed on the screen.</p> <p>Switch to the adult or child measurement mode by dialing the side adult/child switcher according to your measurement needs.</p> <p>Point the thermometer to the sides of the forehead, about 0” to 1” (1-3cm) away from the skin surface. Press and release the <b>Measure button</b>. The temperature will be displayed on the screen.</p>	<p>See the table in the “Sounds and indicator color instructions” section.</p>
Measuring Object temperature		



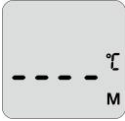
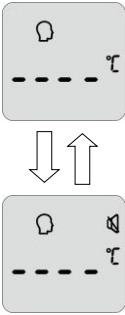

Screen Display	Operating Instructions Displayed State	Sound and Indicator color
	<p>Press and release the <b>Power button</b> for 1 second to power on the thermometer. Then press the <b>Mode button</b>. The thermometer enters the <b>Object mode</b>. The “House” symbol is displayed on the screen.</p> <p>Point the thermometer to the center of the object. Press and release the <b>Measure button</b>. The temperature will be displayed on the screen.</p>	<p>See the table in the “Sounds and indicator color instructions” section.</p>
Out of the measuring range display		
	<p>In Ear mode, a temperature reading of more than 42.0°C (107.6°F)</p> <p>In Forehead mode, a temperature reading of more than 42.2°C (108.0°F)</p> <p>In Object mode, a temperature reading of more than 100°C (212.0°F)</p>	<p>A long beeps, the indicator light is red.</p>
	<p>In Ear mode, a temperature reading of less than 35.0°C (95.0°F)</p> <p>In Forehead mode, a temperature reading of less than 35.0°C (95.0°F)</p> <p>In Object mode, a temperature reading of less than 0°C (32.0°F)</p>	<p>A long beeps, the indicator light is red.</p>
Recall 20 memories		

Screen Display	Operating Instructions Displayed State	Sound and Indicator color
      	<p>In a power-on state, press the <b>Memory button</b> enter the memory mode.</p> <p>When the <b>Memory button</b> is released, <b>1</b> will be shown, followed by the recorded reading.</p> <p>Press the <b>Memory button</b> again for the next recorded data. <b>2</b> will be shown, followed by the recorded reading.</p> <p>A maximum of 20 temperature readings can be recalled.</p> <p>When the maximum number of records is exceeded, the oldest memory data will be overwritten.</p> <p><b>Note:</b> <b>1</b> represents the newest data.</p>	<p>Silent, the indicator light is green.</p>
No memory data / Clear memory data		

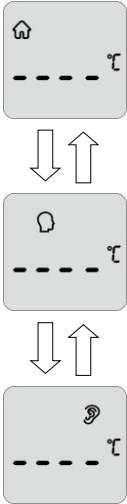
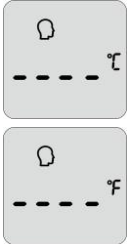
Screen Display	Operating Instructions Displayed State	Sound and Indicator color
	<p>When the memory data is queried, when there is no memory data under the current serial number, the display is as shown.</p> <p>Remove 2 dry batteries and re-install the power to clear all memory data.</p>	<p>When the power is turned back on, a long beep, the indicator light is green, then turn red.</p>
Switching between mute and un-mute		
	<p>In the power-on state, press and hold the sound switch button for about 2 seconds to switch the sound on or off. When the sound is turned on, it will beep once and the mute symbol will be displayed when the sound is off.</p> <p>The  symbol is displayed in Mute mode and disappears in Un-mute mode.</p>	<p>When the sound is turned on, it sounds a long beep and the indicator light is green.</p>
Switching between object temperature and body temperature		

Screen Display	Operating Instructions Displayed State	Sound and Indicator color
	<p>Press the <b>Mode button</b> to switch between object temperature and body temperature.</p> <p>Body temperature contains the Forehead temperature and Ear temperature.</p>	<p>Silent, the indicator light is green.</p>
<p>Switching between °F/°C</p>		
	<p>In the power off state, remove the battery cover, and toggle the ° C/° F unit in the battery compartment to switch the toggle device.</p> <p>Toggle switch for °C upwards and downwards toggle switch as the °F unit.</p>	<p>Silent</p>

Screen Display	Operating Instructions Displayed State	Sound and Indicator color
Error information & low battery		
	<p>The ambient temperature is higher than 40.0°C (104.0°F) or lower than 10.0°C (50.0°F).</p>	<p>A long beeps, the indicator light is red.</p>
	<p>An error occurs when data is being read from or written to the memory, or the temperature correction is not complete.</p>	<p>A long beeps, the indicator light is red.</p>
	<p>When the battery voltage is lower than <math>2.5V \pm 0.1V</math>, the low battery symbol will appear on the display. Please replace the batteries.</p>	<p>Silent</p>

## Measuring Ear Temperature

1. When using the thermometer for the first time, move the battery's insulating piece away.

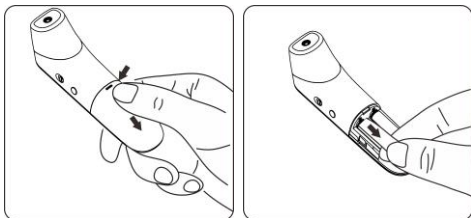

2. Take the probe cover off from the thermometer before measuring the ear temperature.

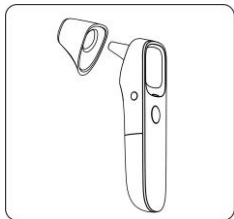



3. Press the **Power button** to power on the thermometer.
4. Press the **Mode button**, the thermometer enters the **Ear mode**. The "Ear" symbol is displayed on the screen.
5. When measuring an adult, place the switching device in the "adult" mode. When measuring children, place the switching device in the "child" mode and the symbol is displayed on the screen.
6. Insert the temperature probe into the ear canal.
7. Press and release the **Measure button**. The ear temperature reading will be display on the screen instantly.

**Note:** Children under 1 year: Pull the ear straight back.

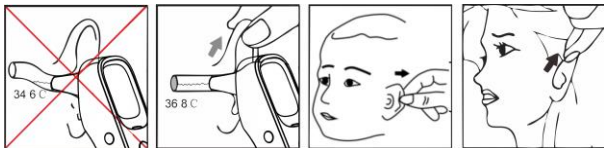
Children aged 1 year to adult: Pull the ear up and back.



 Do not force the thermometer into the ear canal. Otherwise, the ear canal may get injured.

 When taking the temperature on an adult, gently pull the ear up and back to make sure the ear canal is straight, so that the temperature probe can receive an infrared ray from the eardrum.

 Be careful when taking temperature on a child, whose ear canal is small.

## Measuring Forehead Temperature

1. Put the cover on the probe of thermometer.
2. Press the **Power button** to power on the thermometer.
3. Press the **Mode button**, the thermometer enters the **Forehead mode**. the "Head" symbol is displayed on the screen.
4. When measuring adults, place the switching device in the "adult" mode. When measuring children, place the switching device in "child" mode and the symbol is displayed on the screen.
5. Point the thermometer probe to the sides of the forehead, about 0" to 1" (1-3cm) away from the skin surface.

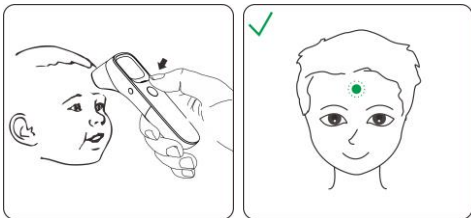

6. Press and release the **Measure button** for 1 second. The temperature reading will be displayed on the screen instantly.
7. If no activity is detected, the thermometer will power off automatically in 10 seconds.

## Measuring Object Temperature

1. Put the cover on the probe of thermometer.
2. Press the **Power button** to power on the thermometer.
3. Press the **Mode button**, the thermometer enters the **Object mode**. The “House” symbol is displayed on the screen.
4. Point the thermometer probe to the center of the object, about 0” to 1” (1-3cm) away from the object surface.
5. Press and release the **Measure button** for 1 second. The temperature reading will be displayed on the screen instantly.
6. If no activity is detected, the thermometer will power off automatically in 10 seconds.



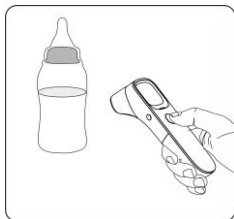

### **After a measurement**

- (1) After each measurement, you can enter the recall mode and query earlier temperature readings. For more details, see "Recall 20 memories" in the preceding table.
- (2) After each measurement, clean the temperature probe with a soft cloth, and put the thermometer in a dry and well-ventilated place.



It is dangerous to make a self-diagnosis or self-treatment based on the obtained measurement results. For such purposes, please consult a doctor.

### **Notes:**

- (1) The thermometer is suitable for an indoor environment without strong air convection (for example, winds from a fan, an air-conditioner, or a heater) between the thermometer and the person.
- (2) Make sure that the ear canal is clean and dry before starting a measurement. It is recommended to clean the ear canal with a cotton swab if any dirt exists. Otherwise, the temperature probe may be polluted and temperature readings may be inaccurate.
- (3) Do not hold the thermometer for a long time, because it is sensitive to the ambient temperature.

- (4) Make sure the sense head is free of foreign matters before use;
- (5) Make sure the forehead has no sweat and no hairs covered before measure the forehead temperature; otherwise, the result could be incorrect;
- (6) No intense emotion or strenuous exercises before measuring;
- (7) After measuring the data once, you should wait for the indicator to turn off and measure the next data.

## Replacing Batteries

- 1、Slide the battery cover off along the marked direction and take it off.
- 2、Insert the two AAA batteries into the compartment according to the stated polarities.

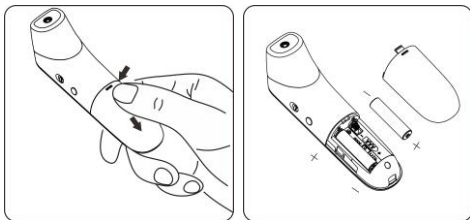

 Make sure that the batteries are installed correctly. Otherwise, the thermometer may be damaged.

 If the low-battery symbol is displayed on the screen, replace the batteries.

 Batteries of a same type should be used. Dispose the used batteries in accordance with the local environmental policies.

 The thermometer is shipped with batteries. First open the battery

cover, then remove the insulating piece.

## **Cleaning and Disinfection**

### **Cleaning**

Recommended detergents:

- \* Medical detergents;
- \* Home use mild detergents;

Cleaning steps:

- (1) Take the batteries out before cleaning.
- (2) Clean the temperature probe with a soft cloth. Clean the lens of the temperature probe with a cotton swab.
- (3) Wipe the thermometer body with a slightly damp soft cloth.

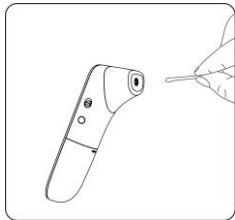

 Keep water out off the lens during the cleaning process. Otherwise, the lens may be damaged.

 The lens may be scratched if it is cleaned with a hard object, which might result in inaccurate readings.

 Do not clean the thermometer with corrosive cleansers. During the cleaning process, do not immerse any part of the thermometer into liquid, or allow liquid to penetrate the thermometer.

### **Disinfection**

Recommended disinfectants:

- \* Isopropyl alcohol solution (concentration: 70%)
- \* Medicinal alcohol (concentration: 75%)

\* Sodium hypochlorite solution (concentration: 3%)

Disinfecting steps:

- 1) Wet the clean soft cloth with a small quantity of disinfectant, wipe the thermometer and quickly dry it.
- 2) Disinfect the thermometer body and the area around the temperature probe with a cloth slightly moistened with 75% medical alcohol.



Do not use hot steam or ultraviolet radiation for disinfection.

Otherwise, the thermometer may be damaged or quickly aged.



Clean and disinfect the thermometer under the temperature of  $+10^{\circ}\text{C}\sim+40^{\circ}\text{C}$  ( $50^{\circ}\text{F}\sim 104^{\circ}\text{F}$ ), the relative humidity of 15%~85%RH (no condensation) and the barometric pressure of 86kPa~106kPa.

## Maintenance

Preventive inspection & maintenance period

- 1) Ensure the safety of thermometer, and check whether it has potential safety hazards in normal use each week, e.g. whether the lens is broken, the shell has cracks and the sensing head is polluted. Do not use the thermometer with potential safety hazard. Clean the thermometer if not used for a long time.
- 2) After each use, clean the temperature probe as described in the "Cleaning and Disinfection" chapter.
- 3) Store the thermometer in a dry, dust-free, and well-ventilated place. Make sure that the thermometer is not exposed to sunlight. Make sure that the storage and transportation environments meet the requirements.

- 4) Check regularly whether safety risks exist.
- 5) Remove the batteries if the thermometer will not be used for more than two months.

## Troubleshooting

Problem	Possible Cause	Solution
The thermometer fails to power on.	Low battery	Change the batteries.
	Polarities of the batteries are reversed.	Make sure that the batteries are installed correctly.
	The thermometer is damaged.	Contact the manufacturer.
"Er1" is displayed.	The ambient temperature is lower than 10°C (50.0°F) or higher than 40°C (104°F).	Take a measurement under an ambient temperature between 10°C (50.0°F) and 40°C (104°F).
The temperature reading is lower than the typical body temperature range.	The lens of the temperature probe is dirty.	Clean the lens using a cotton swab.
	The thermometer probe is not aligned to the eardrum.	Reposition the thermometer probe so that it is aligned to the eardrum.
	The thermometer is used within 30 minutes after being taken from a cold environment.	Wait for more than 30 minutes after the thermometer is moved into the measurement environment.
The temperature reading is higher than the typical	The temperature probe is damaged.	Contact the manufacturer.

body temperature range.		
-------------------------	--	--

## Specifications

Product Name	Infrared Thermometer
Product Model	JPD-FR409
Power Supply Mode	Internal power supply
Operating Voltage	DC 3V
Battery Model	AAA x 2
Battery Life	Alkaline dry battery for around 20,000 measurements
Operating Mode	Continuous operating
Display	Segment LCD
Measure time	About 1 second
Latency Time	About 3 second
Measuring Range	Forehead mode:35.0°C–42.2°C (95.0°F–108.0°F) Ear mode:35.0°C–42.0°C (95.0°F–107.6°F) Object mode:0.0°C–100.0°C (32.0°F–212.0°F)
Accuracy (Laboratory)	Forehead mode: $\pm 0.2^{\circ}\text{C}$ ( $\pm 0.4^{\circ}\text{F}$ ) Ear mode: $\pm 0.2^{\circ}\text{C}$ ( $\pm 0.4^{\circ}\text{F}$ ) Object mode: $\pm 1.0^{\circ}\text{C}/\pm 2.0^{\circ}\text{F}$
Resolution	0.1°C (0.1°F)
Memory	20 temperature readings
Low-battery Alert	The low-battery symbol is displayed if the power voltage is lower than 2.5 V $\pm$ 0.1V
Automatic Power-off	The thermometer automatically powers off if it is not used in 10 $\pm$ 1 seconds.
Outer dimensions (mm)	155.2 $\times$ 39.6 $\times$ 49.1mm
Weight (g)	Thermometer (with batteries): 101 g
Operating	Temperature: 10°C~ 40°C (50°F–104°F)

Environment	Humidity: 15%–95% RH, non-condensing
	Atmospheric pressure: 86–106 kPa

The infrared thermometer has been tested and conforms to the standard ASTM E1965-98. ASTM laboratory accuracy requirements in the display range of 96.8°F to 102.2°F (36°C-39°C) for ear canal IR thermometers is  $\pm 0.4^{\circ}\text{F}$  ( $\pm 0.2^{\circ}\text{C}$ ). Note that for mercury-in-glass and electronic thermometers, the requirement per ASTM Standards E667-86 and E1112-86 is  $\pm 0.2^{\circ}\text{F}$  ( $\pm 0.1^{\circ}\text{C}$ ).

## Security Class

Type of protection against electric shock: internally powered equipment.

Degree of protection against electric shock:  Type BF applied part.

- Degree of protection against ingress of water: IPX0
- Safety degree of using in flammable anesthetic gas blending with air, oxygen or nitrous oxide: Non-AP/APG
- No application parts of the thermometer prevents defibrillation charge effect.
- No application parts of the thermometer output signal.
- The thermometer is impermanent installed device.

## Storage and Transportation

The thermometer can be transported using general transportation tools.

Severe vibration, shock, or rain must be avoided during transportation.

The thermometer must be packaged and then stored in a well-ventilated room without corrosive gas. The ambient temperature must be between  $-20^{\circ}\text{C}$  and  $+55^{\circ}\text{C}$  ( $-4^{\circ}\text{F}$ – $131^{\circ}\text{F}$ ), the relative humidity must be lower

than 95% (non-condensing), and the atmospheric pressure must be 50–106 kPa.

## **EMC Information-Guidance and Manufacture's Declaration**



### **CAUTION:**

- The Infrared Thermometer JPD-FR409 needs special precautions regarding EMC and needs to be installed and put into service according to the EMC information provided for in the ACCOMPANYING DOCUMENTS.
- Portable and mobile RF communications equipment can affect Infrared Thermometer JPD-FR409.
- The Infrared Thermometer JPD-FR409 should not be used adjacent to or stacked with other equipment.

### **Guidance and manufacturer's declaration – Electromagnetic emission –for all equipment and systems**

Guidance and manufacturer's declaration – Electromagnetic emission		
The Infrared Thermometer JPD-FR409 is intended for use in the electromagnetic environment specified below. The customer or the user of the Infrared Thermometer JPD-FR409 should assure that it is used in such an environment.		
Emissions test	Compliance	Electromagnetic environment - guidance
RF emissions CISPR 11	Group 1	The Infrared Thermometer JPD-FR409 uses RF energy only for its internal



		function. Therefore, its RF emissions are very low and are not likely to cause any interference in nearby electronic equipment.
RF emissions CISPR 11	Class B	The Infrared Thermometer JPD-FR409 is suitable for use in all establishments, including domestic establishments and those directly connected to the public low-voltage power supply network that supplies buildings used for domestic purposes.

**Guidance and manufacturer's declaration – Electromagnetic immunity –for all equipment and systems**

Guidance and manufacturer's declaration – Electromagnetic immunity			
The Infrared Thermometer JPD-FR409 is intended for use in the electromagnetic environment specified below. The customer or the user of the Infrared Thermometer JPD-FR409 should assure that it is used in such an environment.			
Immunity test	IEC 60601 test level	Compliance level	Electromagnetic environment- guidance
Electrostatic discharge (ESD)	±6kV contact	±6 kV contact  ±8 kV air	Floors should be wood, concrete or ceramic tile. If floors are covered with

IEC 61000-4-2	±8 kV air		synthetic material, the relative humidity should be at least 30 %.
Power frequency (50/60 Hz) magnetic field IEC 61000-4-8	3 A/m	3 A/m	Power frequency magnetic fields should be at levels characteristic of a typical location in a typical commercial or hospital environment.

**Guidance and manufacturer's declaration – Electromagnetic immunity –for equipment and systems that are not life-supporting**

Guidance and manufacturer's declaration – Electromagnetic immunity			
The Infrared Thermometer JPD-FR409 is intended for use in the electromagnetic environment specified below. The customer or the user of the Infrared Thermometer JPD-FR409 should assure that it is used in such an environment.			
Immunity test	IEC 60601 test level	Compliance level	Electromagnetic environment -guidance
Radiated RF IEC 61000-4-3	3 V/m 80 MHz to 2.5 GHz	3 V/m	Portable and mobile RF communications equipment should be used no closer to any part of the JPDFR409, including cables, than the recommended

			<p>separation distance calculated from the equation applicable to the frequency of the transmitter.</p> <p>Recommended separation distance</p> $d = \left[ \frac{3.5}{E_1} \right] \sqrt{P} \quad 80 \text{ MHz to } 800 \text{ MHz}$ $d = \left[ \frac{7}{E_1} \right] \sqrt{P} \quad 800 \text{ MHz to } 2.5 \text{ GHz}$ <p>where p is the maximum output power rating of the transmitter in watts (W) according to the transmitter manufacturer and d is the recommended separation distance in metres (m).<sup>b</sup></p> <p>Field strengths from fixed RF transmitters, as determined by an Electromagnetic site survey,<sup>a</sup> should be less than the compliance level in each frequency range.<sup>b</sup></p> <p>Interference may occur in the vicinity of equipment marked with the following</p>
--	--	--	--

			symbol: 
NOTE 1 At 80 MHz and 800 MHz, the higher frequency range applies.			
NOTE 2 These guidelines may not apply in all situations. Electromagnetic is affected by absorption and reflection from structures, objects and people.			
<p>a. Field strengths from fixed transmitters, such as base stations for radio (cellular/cordless) telephones and land mobile radios, amateur radio, AM and FM radio broadcast and TV broadcast cannot be predicted theoretically with accuracy. To assess the electromagnetic environment due to fixed RF transmitters, an electromagnetic site survey should be considered. If the measured field strength in the location in which the JPD-FR409 is used exceeds the applicable RF compliance level above, the JPD-FR409 should be observed to verify normal operation. If abnormal performance is observed, additional measures may be necessary, such as re-orienting or relocating the JPD-FR409.</p> <p>b. Over the frequency range 150 kHz to 80 MHz, field strengths should be less than 3 V/m.</p>			

**Recommended separation distances between portable and mobile RF communications equipment and the EQUIPMENT or SYSTEM -for EQUIPMENT and SYSTEMS that are not LIFE-SUPPORTING**

The Infrared Thermometer JPD-FR409 is intended for use in an electromagnetic environment in which radiated RF disturbances are controlled. The customer or the user of the Infrared Thermometer JPD-FR409 can help prevent electromagnetic interference by maintaining a minimum distance

between portable and mobile RF communications equipment (transmitters) and the Infrared Thermometer JPD-FR409 as recommended below, according to the maximum output power of the communications equipment.

Rated maximum output power of transmitter W	Separation distance according to frequency of transmitter m	
	80 MHz to 800 MHz	800 MHz to 2,5 GHz
	$d = \left[ \frac{3.5}{E_1} \right] \sqrt{P}$	$d = \left[ \frac{7}{E_1} \right] \sqrt{P}$
0.01	0.12	0.23
0.1	0.38	0.73
1	1.2	2.3
10	3.8	7.3
100	12	23

For transmitters rated at a maximum output power not listed above, the recommended separation distance  $d$  in metres (m) can be estimated using the equation applicable to the frequency of the transmitter, where  $P$  is the maximum output power rating of the transmitter in watts (W) according to the transmitter manufacturer.

NOTE 1 At 80 MHz and 800 MHz, the separation distance for the higher frequency range applies.

NOTE 2 These guidelines may not apply in all situations. Electromagnetic propagation is affected by absorption and reflection from structures, objects and people.

## **Warranty and After-Sale Service**

The device is under warranty for one year from the date of purchase.

The batteries, the packaging, and any damage caused by improper use are not covered by the warranty.

Excluding the following user-caused failures:

- 1.Failure resulting from unauthorized disassembly and modification.
- 2.Failure resulting from an unexpected dropping during application or transportation.
- 3.Failure resulting from not following the instructions in the user's manual.

### **Authorized European Representative:**



Wellkang Ltd

Suite B, 29 Harley Street, London W1G 9QR, UK.



# JUMPER

---



Shenzhen Jumper Medical Equipment Co., Ltd.  
Address: D Building, No. 71, Xintian Road, Fuyong Street,  
Baoan, Shenzhen, Guangdong, China  
Tel:+86-755-26696279  
Fax:+86-755-26852025  
Website: <http://www.jumper-medical.com>